

Chapter 4

Buffer Overflow Attack

From Morris worm in 1988, Code Red worm in 2001, SQL Slammer in 2003, to Stagefright attack against Android phones in 2015, the buffer overflow attack has played a significant role in the history of computer security. It is a classic attack that is still effective against many of the computer systems and applications. In this chapter, we will study the buffer overflow vulnerability, and see how such a simple mistake can be exploited by attackers to gain a complete control of a system. We will also study how to prevent such attacks.

4.1 Program Memory Layout

To fully understand how buffer overflow attacks work, we need to understand how the data memory is arranged inside a process. When a program runs, it needs memory space to store data. For a typical C program, its memory is divided into five segments, each with its own purpose. Figure 4.1 depicts the five segments in a process's memory layout.

- Text segment: stores the executable code of the program. This block of memory is usually read-only.
- Data segment: stores static/global variables that are initialized by the programmer. For example, the variable `a` defined in `static int a = 3` will be stored in the Data segment.
- BSS segment: stores uninitialized static/global variables. This segment will be filled with zeros by the operating system, so all the uninitialized variables are initialized with zeros. For example, the variable `b` defined in `static int b` will be stored in the BSS segment, and it is initialized with zero.
- Heap: The heap is used to provide space for dynamic memory allocation. This area is managed by `malloc`, `calloc`, `realloc`, `free`, etc.
- Stack: The stack is used for storing local variables defined inside functions, as well as storing data related to function calls, such as return address, arguments, etc. We will provide more details about this segment later on.

To understand how different memory segments are used, let us look at the following code.

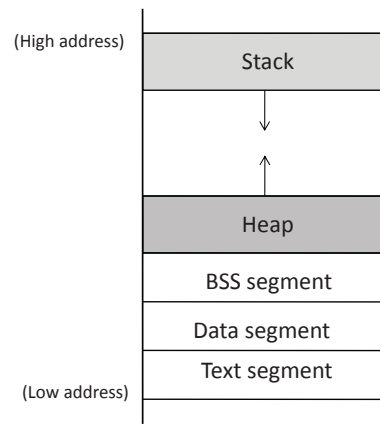

Figure 4.1: Program memory layout

```
int x = 100;
int main()
{
    // data stored on stack
    int a=2;
    float b=2.5;
    static int y;

    // allocate memory on heap
    int *ptr = (int *) malloc(2*sizeof(int));

    // values 5 and 6 stored on heap
    ptr[0]=5;
    ptr[1]=6;

    // deallocate memory on heap
    free(ptr);

    return 1;
}
```

In the above program, the variable `x` is a global variable initialized inside the program; this variable will be allocated in the Data segment. The variable `y` is a static variable that is uninitialized, so it is allocated in the BSS segment. The variables `a` and `b` are local variables, so they are stored on the program's stack. The variable `ptr` is also a local variable, so it is also stored on the stack. However, `ptr` is a pointer, pointing to a block of memory, which is dynamically allocated using `malloc()`; therefore, when the values 5 and 6 are assigned to `ptr[1]` and `ptr[2]`, they are stored in the heap segment.

4.2 Stack and Function Invocation

Buffer overflow can happen on both stack and heap. The ways to exploit them are quite different. In this chapter, we focus on the stack-based buffer overflow. To understand how it works, we need to have an in-depth understanding of how stack works and what information is stored on the stack.

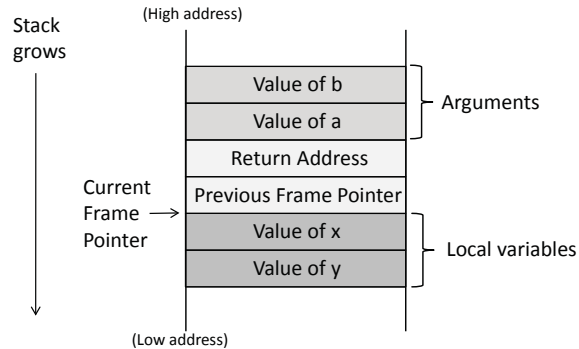

Figure 4.2: Layout for a function's stack frame

4.2.1 Stack Memory Layout

Stack is used for storing data used in function invocations. A program executes as a series of function calls. Whenever a function is called, some space is allocated for it on the stack for the execution of the function. Consider the following sample code for function `func()`, which has two integer arguments (`a` and `b`) and two integer local variables (`x` and `y`).

```
void func(int a, int b)
{
    int x, y;

    x = a + b;
    y = a - b;
}
```

When `func()` is called, a block of memory space will be allocated on the top of the stack, and it is called *stack frame*. The layout of the stack frame is depicted in Figure 4.2. A stack frame has four important regions:

- **Arguments:** This region stores the values for the arguments that are passed to the function. In our case, `func()` has two integer arguments. When this function is called, e.g., `func(5, 8)`, the values of the arguments will be pushed into the stack, forming the beginning of the stack frame. It should be noted that the arguments are pushed in the reverse order; the reason will be discussed later after we introduce the frame pointer.
- **Return Address:** When the function finishes and hits its `return` instruction, it needs to know where to return to, i.e., the return address needs to be stored somewhere. Before jumping to the entrance of the function, the computer pushes the address of the next

instruction—the instruction placed right after the function invocation instruction—into the top of the stack, which is the “return address” region in the stack frame.

- **Previous Frame Pointer:** The next item pushed into the stack frame by the program is the frame pointer for the previous frame. We will talk about the frame pointer in more details in § 4.2.2.
- **Local Variables:** The next region is for storing the function’s local variables. The actual layout for this region, such as the order of the local variables, the actual size of the region, etc., is up to the compilers. Some compilers may randomize the order of the local variables, or give extra space for this region [Bryant and O’Hallaron, 2015]. Programmers should not assume any particular order or size for this region.

4.2.2 Frame Pointer

Inside `func()`, we need to access the arguments and local variables. The only way to do that is to know their memory addresses. Unfortunately, the addresses cannot be determined during the compilation time, because compilers cannot predict the run-time status of the stack, and will not be able to know where the stack frame will be. To solve this problem, a special register is introduced in the CPU. It is called *frame pointer*. This register points to a fixed location in the stack frame, so the address of each argument and local variable on the stack frame can be calculated using this register and an offset. The offset can be decided during the compilation time, while the value of the frame pointer can change during the runtime, depending on where a stack frame is allocated on the stack.

Let us use an example to see how the frame pointer is used. From the code example shown previously, the function needs to execute the `x = a + b` statement. CPU needs to fetch the values of `a` and `b`, add them, and then store the result in `x`; CPU needs to know the addresses of these three variables. As shown in Figure 4.2, in the x86 architecture, the frame pointer register (`ebp`) always points to the region where the previous frame pointer is stored. For the 32-bit architecture, the return address and frame pointer both occupy 4 bytes of memory, so the actual address of the variables `a` and `b` is `ebp + 8`, and `ebp + 12`, respectively. Therefore, the assembly code for `x = a + b` is the following (we can compile C code into assembly code using the `-S` option of `gcc` like this: `gcc -S <filename>`):

```
movl    12(%ebp), %eax    ; b is stored in %ebp + 12
movl    8(%ebp), %edx     ; a is stored in %ebp + 8
addl    %edx, %eax
movl    %eax, -8(%ebp)   ; x is stored in %ebp - 8
```

In the above assembly code, `eax` and `edx` are two general-purpose registers used for storing temporary results. The “`movl u w`” instruction copies value `u` to `w`, while “`addl %edx %eax`” adds the values in the two registers, and save the result to `%eax`. The notation `12(%ebp)` means `%ebp+12`. It should be noted that the variable `x` is actually allocated 8 bytes below the frame pointer by the compiler, not 4 bytes as what is shown in the diagram. As we have already mentioned, the actual layout of the local variable region is up to the compiler. In the assembly code, we can see from `-8(%ebp)` that the variable `x` is stored in the location of `%ebp-8`. Therefore, using the frame pointer decided at the runtime and the offsets decided at the compilation time, we can find the address of all the variables.

Now we can explain why `a` and `b` are pushed in the stack in a seemingly reversed order. Actually, the order is not reversed from the offset point of view. Since the stack grows from high

address to low address, if we push `a` first, the offset for argument `a` is going to be larger than the offset of argument `b`, making the order look actually reversed if we read the assembly code.

Previous frame pointer and function call chain. In a typical program, we may call another function from inside a function. Every time we enter a function, a stack frame is allocated on the top of the stack; when we return from the function, the space allocated for the stack frame is released. Figure 4.3 depicts the stack situation where from inside of `main()`, we call `foo()`, and from inside of `foo()`, we call `bar()`. All three stack frames are on the stack.

There is only one frame pointer register, and it always points to the stack frame of the current function. Therefore, before we enter `bar()`, the frame pointer points to the stack frame of the `foo()` function; when we jump into `bar()`, the frame pointer will point to the stack frame of the `bar()` function. If we do not remember what the frame pointer points to before entering `bar()`, once we return from `bar()`, we will not be able to know where function `foo()`'s stack frame is. To solve this problem, before entering the callee function, the caller's frame pointer value is stored in the "previous frame pointer" field on the stack. When the callee returns, the value in this field will be used to set the frame pointer register, making it point to the caller's stack frame again.

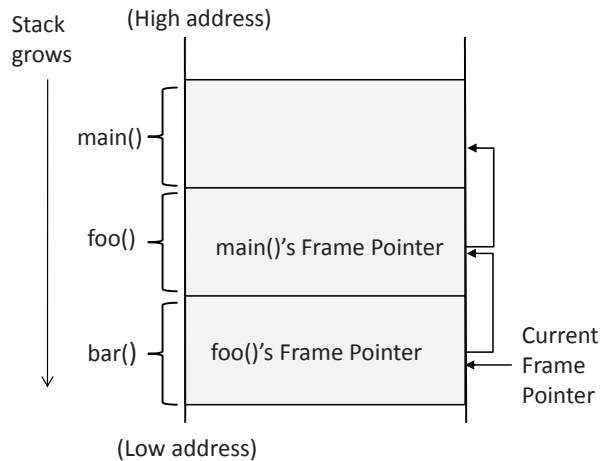

Figure 4.3: Stack layout for function call chain

4.3 Stack Buffer-Overflow Attack

Memory copying is quite common in programs, where data from one place (source) need to be copied to another place (destination). Before copying, a program needs to allocate memory space for the destination. Sometimes, programmers may make mistakes and fail to allocate sufficient amount of memory for the destination, so more data will be copied to the destination buffer than the amount of allocated space. This will result in an overflow. Some programming languages, such as Java, can automatically detect the problem when a buffer is over-run, but many other languages such as C and C++ are not be able to detect it. Most people may think that the only damage a buffer overflow can cause is to crash a program, due to the corruption of the data beyond the buffer; however, what is surprising is that such a simple mistake may enable

attackers to gain a complete control of a program, rather than simply crashing it. If a vulnerable program runs with privileges, attackers will be able to gain those privileges. In this section, we will explain how such an attack works.

4.3.1 Copy Data to Buffer

There are many functions in C that can be used to copy data, including `strcpy()`, `strcat()`, `memcpy()`, etc. In the examples of this section, we will use `strcpy()`, which is used to copy strings. An example is shown in the code below. The function `strcpy()` stops copying only when it encounters the terminating character `'\0'`.

```
#include <string.h>
#include <stdio.h>

void main ()
{
    char src[40]="Hello world \0 Extra string";
    char dest[40];

    // copy to dest (destination) from src (source)
    strcpy (dest, src);
}
```

When we run the above code, we can notice that `strcpy()` only copies the string "Hello world" to the buffer `dest`, even though the entire string contains more than that. This is because when making the copy, `strcpy()` stops when it sees number zero, which is represented by `'\0'` in the code. It should be noted that this is not the same as character `'0'`, which is represented as `0x30` in computers, not zero. Without the zero in the middle of the string, the string copy will end when it reaches the end of the string, which is marked by a zero (the zero is not shown in the code, but compilers will automatically add a zero to the end of a string).

4.3.2 Buffer Overflow

When we copy a string to a target buffer, what will happen if the string is longer than the size of the buffer? Let us see the following example.

```
#include <string.h>

void foo(char *str)
{
    char buffer[12];

    /* The following statement will result in buffer overflow */
    strcpy(buffer, str);
}

int main()
{
    char *str = "This is definitely longer than 12";
}
```

```

foo(str);

return 1;
}

```

The stack layout for the above code is shown in Figure 4.4. The local array `buffer[]` in `foo()` has 12 bytes of memory. The `foo()` function uses `strcpy()` to copy the string from `str` to `buffer[]`. The `strcpy()` function does not stop until it sees a zero (a number zero, `'\0'`) in the source string. Since the source string is longer than 12 bytes, `strcpy()` will overwrite some portion of the stack above the buffer. This is called *buffer overflow*.

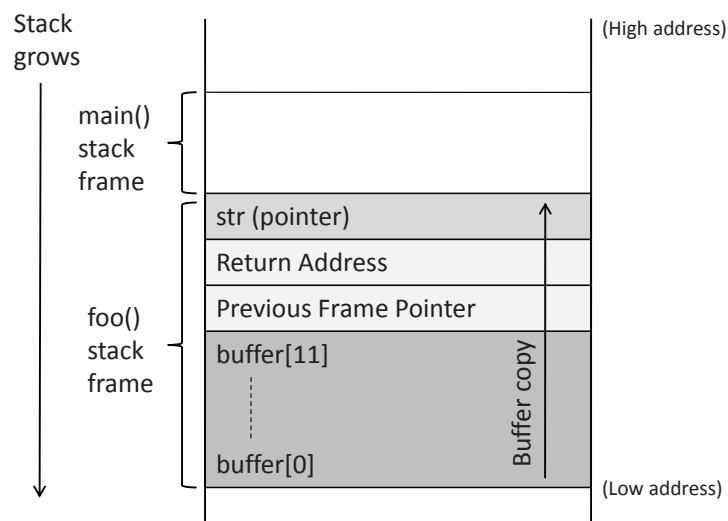

Figure 4.4: Buffer overflow

It should be noted that stacks grow from high address to low address, but buffers still grow in the normal direction (i.e., from low to high). Therefore, when we copy data to `buffer[]`, we start from `buffer[0]`, and eventually to `buffer[11]`. If there are still more data to be copied, `strcpy()` will continue copying the data to the region above the buffer, treating the memory beyond the buffer as `buffer[12]`, `buffer[13]`, and so on.

Consequence. As can be seen in Figure 4.4, the region above the buffer includes critical values, including the return address and the previous frame pointer. The return address affects where the program should jump to when the function returns. If the return address field is modified due to a buffer overflow, when the function returns, it will return to a new place. Several things can happen. First, the new address, which is a virtual address, may not be mapped to any physical address, so the return instruction will fail, and the program will crash. Second, the address may be mapped to a physical address, but the address space is protected, such as those used by the operating system kernel; the jump will fail, and the program will crash. Third, the address may be mapped to a physical address, but the data in that address is not a valid machine instruction (e.g. it may be a data region); the return will again fail and the program will crash. Fourth, the data in the address may happen to be a valid machine instruction, so the

program will continue running, but the logic of the program will be different from the original one.

4.3.3 Exploiting a Buffer Overflow Vulnerability

As we can see from the above consequence, by overflowing a buffer, we can cause a program to crash or to run some other code. From the attacker's perspective, the latter sounds more interesting, especially if we (as attackers) can control what code to run, because that will allow us to hijack the execution of the program. If a program is privileged, being able to hijack the program leads to privilege escalation for the attacker.

Let us see how we can get a vulnerable program to run our code. In the previous program example, the program does not take any input from outside, so even though there is a buffer overflow problem, attackers cannot take advantage of it. In real applications, programs usually get inputs from users. See the following program example.

Listing 4.1: The vulnerable program `stack.c`

```
/* stack.c */
/* This program has a buffer overflow vulnerability. */
#include <stdlib.h>
#include <stdio.h>
#include <string.h>

int foo(char *str)
{
    char buffer[100];

    /* The following statement has a buffer overflow problem */
    strcpy(buffer, str);

    return 1;
}

int main(int argc, char **argv)
{
    char str[400];
    FILE *badfile;

    badfile = fopen("badfile", "r");
    fread(str, sizeof(char), 300, badfile);
    foo(str);

    printf("Returned Properly\n");
    return 1;
}
```

The above program reads 300 bytes of data from a file called "badfile", and then copies the data to a buffer of size 100. Clearly, there is a buffer overflow problem. This time, the contents copied to the buffer come from a user-provided file, i.e., users can control what is copied to the buffer. The question is what to store in "badfile", so after overflowing the buffer, we can get the program to run our code.

We need to get our code (i.e., malicious code) into the memory of the running program first. This is not difficult. We can simply place our code in "badfile", so when the program reads from the file, the code is loaded into the `str[]` array; when the program copies `str` to the target buffer, the code will then be stored on the stack. In Figure 4.5, we place the malicious code at the end of "badfile".

Next, we need to force the program to jump to our code, which is already in the memory. To do that, using the buffer overflow problem in the code, we can overwrite the return address field. If we know the address of our malicious code, we can simply use this address to overwrite the return address field. Therefore, when the function `foo` returns, it will jump to the new address, where our code is stored. Figure 4.5 illustrates how to get the program to jump to our code.

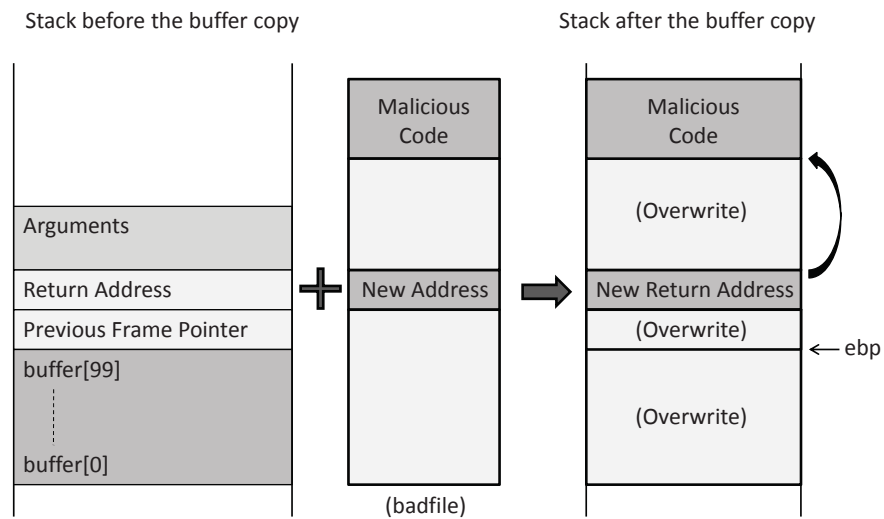

Figure 4.5: Insert and jump to malicious code

In theory, that is how a buffer overflow attack works. In practice, it is far more complicated. In the next few sections, we will describe how to actually launch a buffer overflow attack against the vulnerable `Set-UID` program described in Listing 4.1. We will describe the challenges in the attack and how to overcome them. Our goal is to gain the root privilege by exploiting the buffer overflow vulnerability in a privileged program.

4.4 Setup for Our Experiment

We will conduct attack experiments inside our `Ubuntu12.04` virtual machine. Because the buffer overflow problem has a long history, most operating systems have already developed countermeasures against such an attack. To simplify our experiments, we first need to turn off these countermeasures. Later on, we will turn them back on, and show that some of the countermeasures only made attacks more difficult, not impossible. We will show how they can be defeated.

4.4.1 Disable Address Randomization

One of the countermeasures against buffer overflow attacks is the Address Space Layout Randomization (ASLR) [Wikipedia, 2017a]. It randomizes the memory space of the key data areas in a process, including the base of the executable and the positions of the stack, heap and libraries, making it difficult for attackers to guess the address of the injected malicious code. We will discuss this countermeasure in § 4.8 and show how it can be defeated. For this experiment, we will simply turn it off using the following command:

```
$ sudo sysctl -w kernel.randomize_va_space=0
```

4.4.2 Vulnerable Program

Our goal is to exploit a buffer overflow vulnerability in a Set-UID root program. A Set-UID root program runs with the root privilege when executed by a normal user, giving the normal user extra privileges when running this program. The Set-UID mechanism is covered in details in Chapter 1. If a buffer overflow vulnerability can be exploited in a privileged Set-UID root program, the injected malicious code, if executed, can run with the root's privilege. We will use the vulnerable program (`stack.c`) shown in Listing 4.1 as our target program. This program can be compiled and turned into a root-owned Set-UID program using the following commands:

```
$ gcc -o stack -z execstack -fno-stack-protector stack.c
$ sudo chown root stack
$ sudo chmod 4755 stack
```

The first command compiles `stack.c`, and the second and third commands turn the executable `stack` into a root-owned Set-UID program. It should be noted that the order of the second and third commands cannot be reversed, because when the `chown` command changes the ownership of a file, it clears the Set-UID bit (for the sake of security). In the first command, we used two `gcc` options to turn off two countermeasures that have already been built into the `gcc` compiler.

- `-z execstack`: The option makes the stack non-executable, which prevents the injected malicious code from getting executed. This countermeasure is called non-executable stack [Wikipedia, 2017c]. A program, through a special marking in the binary, can tell the operating system whether its stack should be set to executable or not. The marking in the binary is typically done by the compiler. The `gcc` compiler marks stack as non-executable by default, and the `"-z execstack"` option reverses that, making stack executable. It should be noted that this countermeasure can be defeated using the *return-to-libc* attack. We will cover the attack in Chapter 5.
- `-fno-stack-protector`: This option turns off another countermeasure called StackGuard [Cowa et al., 1998], which can defeat the stack-based buffer overflow attack. Its main idea is to add some special data and checking mechanisms to the code, so when a buffer overflow occurs, it will be detected. More details of this countermeasure will be explained in § 4.9. This countermeasure has been built into the `gcc` compiler as a default option. The `-fno-stack-protector` tells the compiler not to use the StackGuard countermeasure.

To understand the behavior of this program, we place some random contents to `badfile`. We can notice that when the size of the file is less than 100 bytes, the program will run without a problem. However, when we put more than 100 bytes in the file, the program may crash. This is what we expect when a buffer overflow happens. See the following experiment:

```
$ echo "aaaa" > badfile
$ ./stack
Returned Properly
$
$ echo "aaa ...(100 characters omitted)... aaa" > badfile
$ ./stack
Segmentation fault (core dumped)
```

4.5 Conduct Buffer-Overflow Attack

Our goal is to exploit the buffer overflow vulnerability in the vulnerable program `stack.c` (Listing 4.1), which runs with the root privilege. We need to construct the `badfile` such that when the program copies the file contents into a buffer, the buffer is overflowed, and our injected malicious code can be executed, allowing us to obtain a root shell. This section will first discuss the challenges in the attack, followed by a breakdown of how we overcome the challenges.

4.5.1 Finding the Address of the Injected Code

To be able to jump to our malicious code, we need to know the memory address of the malicious code. Unfortunately, we do not know where exactly our malicious code is. We only know that our code is copied into the target buffer on the stack, but we do not know the buffer's memory address, because the buffer's exact location depends on the program's stack usage.

We know the offset of the malicious code in our input, but we need to know the address of the function `foo`'s stack frame to calculate exactly where our code will be stored. Unfortunately, the target program is unlikely to print out the value of its frame pointer or the address of any variable inside the frame, leaving us no choice but to guess. In theory, the entire search space for a random guess is 2^{32} addresses (for 32 bit machine), but in practice, the space is much smaller.

Two facts make the search space small. First, before countermeasures are introduced, most operating systems place the stack (each process has one) at a fixed starting address. It should be noted that the address is a virtual address, which is mapped to a different physical memory address for different processes. Therefore, there is no conflict for different processes to use the same virtual address for its stack. Second, most programs do not have a deep stack. From Figure 4.3, we see that stack can grow deep if the function call chain is long, but this usually happens in recursive function calls. Typically, call chains are not very long, so in most programs, stacks are quite shallow. Combining the first and second facts, we can tell that the search space is much smaller than 2^{32} , so guessing the correct address should be quite easy.

To verify that stacks always start from a fixed starting address, we use the following program to print out the address of a local variable in a function.

```
#include <stdio.h>
void func(int* a1)
{
    printf(" :: a1's address is 0x%x \n", (unsigned int) &a1);
}
```

```

}

int main()
{
    int x = 3;
    func(&x);
    return 1;
}

```

We run the above program with the address randomization turned off. From the following execution trace, we can see that the variable's address is always the same, indicating that the starting address for the stack is always the same.

```

$ sudo sysctl -w kernel.randomize_va_space=0
kernel.randomize_va_space = 0
$ gcc prog.c -o prog
$ ./prog
:: a1's address is 0xbffff370

$ ./prog
:: a1's address is 0xbffff370

```

4.5.2 Improving Chances of Guessing

For our guess to be successful, we need to guess the exact entry point of our injected code. If we miss by one byte, we fail. This can be improved if we can create many entry points for our injected code. The idea is to add many No-Op (NOP) instructions before the actual entry point of our code. The NOP instruction advances the program counter to the next location, so as long as we hit any of the NOP instructions, eventually, we will get to the actual starting point of our code. This will increase our success rate very significantly. The idea is illustrated in Figure 4.6.

By filling the region above the return address with NOP values, we can create multiple entry points for our malicious code. This is shown on the right side of Figure 4.6. This can be compared to the case on the left side, where NOP is not utilized and we have only one entry point for the malicious code.

4.5.3 Finding the Address Without Guessing

In the `Set-UID` case, since attackers are on the same machine, they can get a copy of the victim program, do some investigation, and derive the address for the injected code without a need for guessing. This method may not be applicable for remote attacks, where attackers try to inject code from a remote machine. Remote attackers may not have a copy of the victim program; nor can they conduct investigation on the target machine.

... Several paragraphs are omitted from here for this sample chapter ...

4.5.4 Constructing the Input File

We can now construct the contents for `badfile`. Figure 4.7 illustrates the structure of the input file (i.e. `badfile`). Since `badfile` contains binary data that are difficult to type using a text editor, we write a program (called `exploit.c`) to generate the file. The code is shown below.

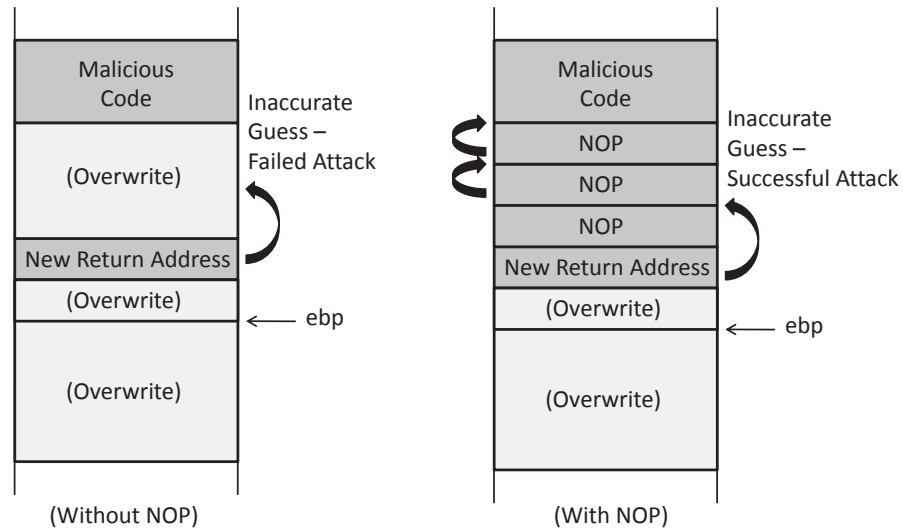

Figure 4.6: Using NOP to improve the success rate

Listing 4.2: The program `exploit.c` used for generating malicious input

```

/* exploit.c */
... code is omitted for this sample chapter ...
}

```

In the given code, the array `shellcode[]` contains a copy of the malicious code. We will discuss how to write such code later. Statement A fills the buffer with NOP instructions. Statement B fills the return address field of the input with the value derived using `gdb`. Statement C places the malicious shell code at the end of the buffer.

It should be noted that in Statement B, we do not use `0xbffff188 + 8`, as we have calculated before; instead, we use a larger value `0xbffff188 + 0x80`. There is a reason for this: the address `0xbffff188` was identified using the debugging method, and the stack frame of the `foo` function may be different when the program runs inside `gdb` as opposed to running directly, because `gdb` may push some additional data onto the stack at the beginning, causing the stack frame to be allocated deeper than it would be when the program runs directly. Therefore, the first address that we can jump to may be higher than `0xbffff188 + 8`. Therefore, we chose to use `0xbffff188 + 0x80`. Readers can try different offsets if their attacks fail.

Another important thing to remember is that the result of `0xbffff188 + nnn` should not contain a zero in any of its byte, or the content of `badfile` will have a zero in the middle, causing the `strcpy()` function to end the copying earlier, without copying anything after the zero. For example, if we use `0xbffff188 + 0x78`, we will get `0xbffff200`, and the last byte of the result is zero.

Run the exploit. We can now compile `exploit.c`, and run it to generate `badfile`. Once the file is constructed, we run the vulnerable `Set-UID` program, which copies the contents from `badfile`, resulting in a buffer overflow. The following result shows that we have successfully

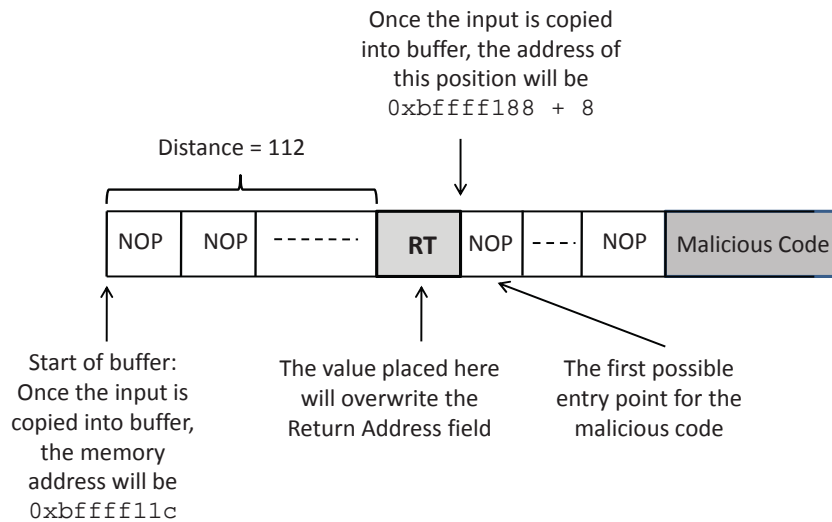

Figure 4.7: The structure of badfile

obtained the root privilege: we get the # prompt, and the result of the `id` command shows that the effective user id (euid) of the process is 0.

```
$ rm badfile
$ gcc exploit.c -o exploit
$ ./exploit
$ ./stack
# id      ← Got the root shell!
uid=1000(seed) gid=1000(seed) euid=0(root) groups=0(root), ...
```

4.6 Writing a Shellcode

Up to this point, we have learned how to inject malicious code into the victim program's memory, and how to trigger the code. What we have not discussed is how to write such malicious code. If an attacker is given a chance to get the victim program to run one command, what command should he/she run? Let me ask a different question: if Genie grants you (instead of Aladdin) a wish, what wish would you make? My wish would be "allowing me to make unlimited number of wishes whenever I want".

Similarly, the ideal command that attackers want to inject is one that allows them to run more commands whenever they want. One command can achieve that goal. That is the shell program. If we can inject code to execute a shell program (e.g. `/bin/sh`), we can get a shell prompt, and can later type whatever commands we want to run.

4.6.1 Writing Malicious Code Using C

Let us write such code using C. The following code executes a shell program (`/bin/sh`) using the `execve()` system call.

```
#include <stddef.h>
void main()
{
    char *name[2];
    name[0] = "/bin/sh";
    name[1] = NULL;
    execve(name[0], name, NULL);
}
```

A naive thought is to compile the above code into binary, and then save it to the input file `badfile`. We then set the targeted return address field to the address of the `main()` function, so when the vulnerable program returns, it jumps to the entrance of the above code. Unfortunately this does not work for several reasons.

- The loader issue: Before a normal program runs, it needs to be loaded into memory and its running environment needs to be set up. These jobs are conducted by the OS loader, which is responsible for setting up the memory (such as stack and heap), copying the program into memory, invoking the dynamic linker to link to the needed library functions, etc. After all the initialization is done, the `main()` function will be triggered. If any of the steps is missing, the program will not be able to run correctly. In a buffer overflow attack, the malicious code is not loaded by the OS; it is loaded directly via memory copy. Therefore, all the essential initialization steps are missing; even if we can jump to the `main()` function, we will not be able to get the shell program to run.
- Zeros in the code: String copying (e.g. using `strcpy()`) will stop when a zero is found in the source string. When we compile the above C code into binary, at least three zeros will exist in the binary code:
 - There is a `'\0'` at the end of the `"/bin/sh"` string.
 - There are two `NULL`'s, which are zeros.
 - Whether the zeros in `name[0]` will become zeros in the binary code depends on the program compilation.

4.6.2 Writing a Shellcode: Main Idea

Given the above issues, we cannot use the binary generated directly from a C program as our malicious code. It is better to write the program directly using the assembly language. The assembly code for launching a shell is referred to as *shellcode* [Wikipedia, 2017d]. The core part of a shellcode is to use the `execve()` system call to execute `"/bin/sh"`. To use the system call, we need to set four registers as follows:

- `%eax`: must contain 11, which is the system call number for `execve()`.
- `%ebx`: must contain the address of the command string (e.g. `"/bin/sh"`).

- `%ecx`: must contain the address of the argument array; in our case, the first element of the array points to the `"/bin/sh"` string, while the second element is 0 (which marks the end of the array).
- `%edx`: must contain the address of the environment variables that we want to pass to the new program. We can set it to 0, as we do not want to pass any environment variable.

Setting these four registers are not difficult; the difficulty is in preparing the data, finding the addresses of those data, and making sure that there is no zeros in the binary code. For example, to set the value for `%ebx`, we need to know the address of the `"/bin/sh"` string. We can put the string on the stack using the buffer overflow, but we may not be able to know its exact memory address. To eliminate guessing involved in finding the address, a common idea is to use the stack pointer (the `%esp` register), as long as we can figure out the offset of the string from the current stack pointer's position. To achieve this goal, instead of copying the string to the stack via a buffer overflow, we can dynamically push the string into the stack; this way, we can get its address from the `%esp` register, which always points to the top of the stack.

To ensure that the entire code is copied into the target buffer, it is important not to include any zeros in the code, because some functions treat zero as the end of the source buffer. Although zeros are used by the program, we do not need to have zeros in the code; instead, we can generate zeros dynamically. There are many ways to generate zeros. For example, to place a zero in the `%eax` register, we can use the `mov` instruction to put a zero in it, but that will cause zero to appear in the code. An alternative is to use `"xorl %eax, %eax"`, which XORs the register with itself, causing its content to become zero.

4.6.3 Explanation of a Shellcode Example

There are many ways to write a shellcode, more details about shellcode writing can be found in [One, 1996] and many online articles. We use a shellcode example to illustrate one way to write such code. The code is shown below. We have already placed the machine instructions into a C array in the following C code, and the comment fields show the assembly code for each machine instruction.

```
const char code[] =
  "\x31\xc0" /* xorl    %eax,%eax    */
  "\x50"     /* pushl  %eax          */
  "\x68""//sh" /* pushl  $0x68732f2f  */
  "\x68""/bin" /* pushl  $0x6e69622f  */
  "\x89\xe3" /* movl   %esp,%ebx    */ ← set %ebx
  "\x50"     /* pushl  %eax          */
  "\x53"     /* pushl  %ebx          */
  "\x89\xe1" /* movl   %esp,%ecx    */ ← set %ecx
  "\x99"     /* cdq                    */ ← set %edx
  "\xb0\x0b" /* movb   $0x0b,%al    */ ← set %eax
  "\xcd\x80" /* int    $0x80         */ ← invoke execve()
;
```

The goal of the above code is similar to the C program shown before, i.e. to use the `execve()` system call to run `/bin/sh`. A system call is executed using the instruction `int $0x80` (the last instruction in the shellcode above). To run it, several parameters need to be prepared in various registers (`%eax`, `%ebx`, `%ecx`, and `%edx`) as mentioned before. If the

registers are configured correctly and the `int $0x80` instruction is executed, the system call `execve()` will be executed to launch a shell. If the program runs with the root privilege, a root shell will be obtained.

Before diving into the details of the above shellcode, we need to know the current state of the stack before the shellcode gets executed. Figure 4.8(a) shows the stack state before the vulnerable function returns. During the return, the return address will be popped out from the stack, so the `esp` value will advance four bytes. The updated stack state is depicted in Figure 4.8(b).

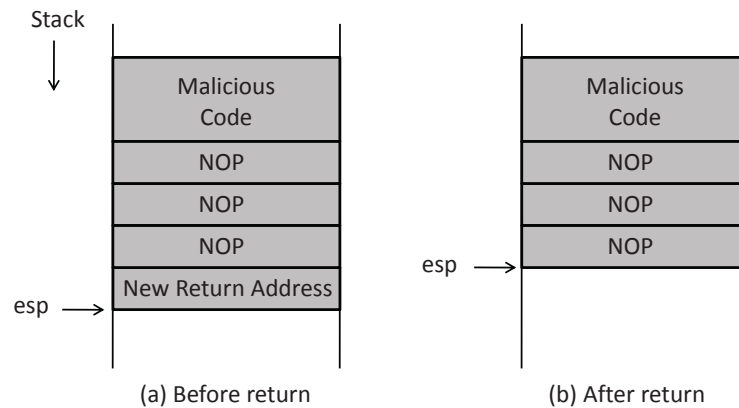

Figure 4.8: The positions of the stack pointer before and after function returns

We will now go over the above shellcode, line by line, to understand how it overcomes the challenges mentioned previously. The code can be divided into four steps.

Step 1: Finding the address of the `"/bin/sh"` string and set `%ebx`. To get the address of the `"/bin/sh"` string, we push this string to the stack. Since the stack grows from high address to low address, and we can only push four bytes at a time, we need to divide the string into 3 pieces, 4 bytes each, and we push the last piece first. Let us look at the code.

- `xorl %eax,%eax`: Using XOR operation on `%eax` will set `%eax` to zero, without introducing a zero in the code.
- `pushl %eax`: Push a zero into the stack. This zero marks the end of the `"/bin/sh"` string.
- `pushl $0x68732f2f`: Push `"/sh"` into the stack (double slash `//` is used because 4 bytes are needed for instruction; double slashes will be treated by the `execve()` system call as the same as a single slash).
- `pushl $0x6e69622f`: Push `"/bin"` into the stack. At this point, the entire string `"/bin//sh"` is on the stack, and the current stack pointer `%esp`, which always point to the top of the stack, now points to the beginning of the string. The state of the stack and the registers at this point is shown in Figure 4.9(a).
- `movl %esp,%ebx`: Move `%esp` to `%ebx`. That is how we save the address of the string to the `%ebx` register without doing any guessing.

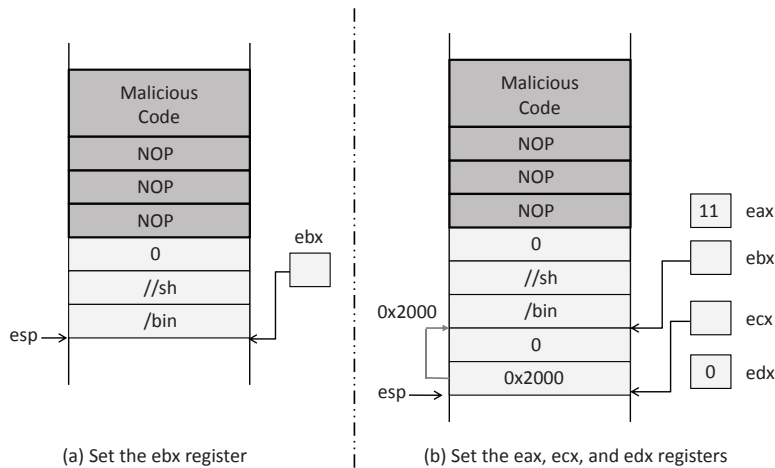

Figure 4.9: Shellcode Execution

Step 2. Finding the address of the `name []` array and set `%ecx`. The next step is to find the address of the `name []` array, which needs to contain two elements, the address of `"/bin/sh"` for `name [0]` and `0` for `name [1]`. We will use the same technique to get the address of the array. Namely, we dynamically construct the array on the stack, and then use the stack pointer to get the array's address.

... Contents are omitted here for this sample chapter ...

Step 3. Setting `%edx` to zero. The `%edx` register needs to be set to zero. We can use the XOR approach, but in order to reduce the code size by one byte, we can leverage a different instruction (`cdq`). This one-byte instruction sets `%edx` to zero as a side effect. It basically copies the sign bit (bit 31) of the value in `%eax` (which is `0` now), into every bit position in `%edx`.

Step 4. Invoking the `execve ()` system call. ... Contents are omitted here for this sample chapter ...

4.7 Countermeasures: Overview

The buffer overflow problem has quite a long history, and many countermeasures have been proposed, some of which have been adopted in real-world systems and software. These countermeasures can be deployed in various places, from hardware architecture, operating system, compiler, library, to the application itself. We first give an overview of these countermeasures, and then study some of them in depth. We will also demonstrate that some of the countermeasures can be defeated.

Safer Functions. Some of the memory copy functions rely on certain special characters in the data to decide whether the copy should end or not. This is dangerous, because the length of the

data that can be copied is now decided by the data, which may be controlled by users. A safer approach is to put the control in the developers' hands, by specifying the length in the code. The length can now be decided based on the size of the target buffer, instead of on the data.

For memory copy functions like `strcpy`, `sprintf`, `strcat`, and `gets`, their safer versions are `strncpy`, `snprintf`, `strncat`, `fgets`, respectively. The difference is that the safer versions require developers to explicitly specify the maximum length of the data that can be copied into the target buffer, forcing the developers to think about the buffer size. Obviously, these safer functions are only relatively safer, as they only make a buffer overflow less likely, but they do not prevent it. If a developer specifies a length that is larger than the actual size of the buffer, there will still be a buffer overflow vulnerability.

Safer Dynamic Link Library. The above approach requires changes to be made to the program. If we only have the binary, it will be difficult to change the program. We can use the dynamic linking to achieve the similar goal. Many programs use dynamic link libraries, i.e., the library function code is not included in a program's binary, instead, it is dynamically linked to the program. If we can build a safer library and get a program to dynamically link to the functions in this library, we can make the program safer against buffer overflow attacks.

An example of such a library is `libsafe` developed by Bell Labs [Baratloo et al., 2000]. It provides a safer version for the standard unsafe functions, which does boundary checking based on `%ebp` and does not allow copy beyond the frame pointer. Another example is the C++ string module `libmib` [mibsoftware.com, 1998]. It conceptually supports "limitless" strings instead of fixed length string buffers. It provides its own versions of functions like `strcpy()` that are safer against buffer overflow attacks.

Program Static Analyzer. Instead of eliminating buffer overflow, this type of solution warns developers of the patterns in code that may potentially lead to buffer overflow vulnerabilities. The solution is often implemented as a command-line tool or in the editor. The goal is to notify developers early in the development cycle of potentially unsafe code in their programs. An example of such a tool is ITS4 by Cigital [Viega et al., 2000], which helps developers identify dangerous patterns in C/C++ code. There are also many academic papers on this approach.

Programming Language. Developers rely on programming languages to develop their programs. If a language itself can do some check against buffer overflow, it can remove the burden from developers. This makes programming language a viable place to implement buffer overflow countermeasures. The approach is taken by several programming languages, such as `Java` and `Python`, which provide automatic boundary checking. Such languages are considered safer for development when it comes to avoiding buffer overflow [OWASP, 2014].

Compiler. Compilers are responsible for translating source code into binary code. They control what sequence of instructions are finally put in the binary. This provides compilers an opportunity to control the layout of stack. It also allows compilers to insert instructions into the binary that can verify the integrity of a stack, as well as eliminating the conditions that are necessary for buffer overflow attacks. Two well-known compiler-based countermeasures are `Stackshield` [Angelfire.com, 2000] and `StackGuard` [Cowa et al., 1998], which check whether the return address has been modified or not before a function returns.

The idea of `Stackshield` is to save a copy of the return address at some safer place. When using this approach, at the beginning of a function, the compiler inserts instructions to copy the

return address to a location (a shadow stack) that cannot be overflowed. Before returning from the function, additional instructions compare the return address on the stack with the one that was saved to determine whether an overflow has happened or not.

The idea of StackGuard is to put a guard between the return address and the buffer, so if the return address is modified via a buffer overflow, this guard will also be modified. When using this approach, at the start of a function, the compiler adds a random value below the return address and saves a copy of the random value (referred to as the canary) at a safer place that is off the stack. Before the function returns, the canary is checked against the saved value. The idea is that for an overflow to occur, the canary must also be overflowed. More details about StackGuard will be given in § 4.9.

Operating System. Before a program is executed, it needs to be loaded into the system, and the running environment needs to be set up. This is the job of the loader program in most operating systems. The setup stage provides an opportunity to counter the buffer overflow problem because it can dictate how the memory of a program is laid out. A common countermeasure implemented at the OS loader program is referred to as Address Space Layout Randomization or ASLR. It tries to reduce the chance of buffer overflows by targeting the challenges that attackers have to overcome. In particular, it targets the fact that attackers must be able to guess the address of the injected shellcode. ASLR randomizes the layout of the program memory, making it difficult for attackers to guess the correct address. We will discuss this approach in details in § 4.8.

Hardware Architecture. The buffer overflow attack described in this chapter depends on the execution of the shellcode, which is placed on the stack. Modern CPUs support a feature called NX bit [Wikipedia, 2017c]. The NX bit, standing for No-eXecute, is a technology used in CPUs to separate code from data. Operating systems can mark certain areas of memory as non-executable, and the processor will refuse to execute any code residing in these areas of memory. Using this CPU feature, the attack described earlier in this chapter will not work anymore, if the stack is marked as non-executable. However, this countermeasure can be defeated using a different technique called *return-to-libc attack*. We will discuss the non-executable stack countermeasure and the return-to-libc attack in Chapter 5.

4.8 Address Randomization

To succeed in buffer overflow attacks, attackers need to get the vulnerable program to “return” (i.e., jump) to their injected code; they first need to guess where the injected code will be. The success rate of the guess depends on the attackers’ ability to predict where the stack is located in the memory. Most operating systems in the past placed the stack in a fixed location, making correct guesses quite easy.

Is it really necessary for stacks to start from a fixed memory location? The answer is no. When a compiler generates binary code from source code, for all the data stored on the stack, their addresses are not hard-coded in the binary code; instead, their addresses are calculated based on the frame pointer `%ebp` and stack pointer `%esp`. Namely, the addresses of the data on the stack are represented as the offset to one of these two registers, instead of to the starting address of the stack. Therefore, even if we start the stack from another location, as long as the `%ebp` and `%esp` are set up correctly, programs can always access their data on the stack without any problem.

For attackers, they need to guess the absolute address, instead of the offset, so knowing the exact location of the stack is important. If we randomize the start location of a stack, we make attackers' job more difficult, while causing no problem to the program. That is the basic idea of the Address Layout Randomization (ASLR) method, which has been implemented by operating systems to defeat buffer overflow attacks. This idea does not only apply to stack, it can also be used to randomize the location of other types of memory, such as heap, libraries, etc.

4.8.1 Address Randomization on Linux

To run a program, an operating system needs to load the program into the system first; this is done by its loader program. During the loading stage, the loader sets up the stack and heap memory for the program. Therefore, memory randomization is normally implemented in the loader. For Linux, ELF is a common binary format for programs, so for this type of binary programs, randomization is carried out by the ELF loader.

To see how the randomization works, we wrote a simple program with two buffers, one on the stack and the other on the heap. We print out their addresses to see whether the stack and heap are allocated in different places every time we run the program.

```
#include <stdio.h>
#include <stdlib.h>

void main()
{
    char x[12];
    char *y = malloc(sizeof(char)*12);

    printf("Address of buffer x (on stack): 0x%x\n", x);
    printf("Address of buffer y (on heap) : 0x%x\n", y);
}
```

After compiling the above code, we run it (`a.out`) under different randomization settings. Users (privileged users) can tell the loader what type of address randomization they want by setting a kernel variable called `kernel.randomize_va_space`. As we can see that when the value 0 is set to this kernel variable, the randomization is turned off, and we always get the same address for buffers `x` and `y` every time we run the code. When we change the value to 1, the buffer on the stack now have a different location, but the buffer on the heap still gets the same address. This is because value 1 does not randomize the heap memory. When we change the value to 2, both stack and heap are now randomized.

```
$ sudo sysctl -w kernel.randomize_va_space=0
kernel.randomize_va_space = 0
$ a.out
Address of buffer x (on stack): 0xbffff370
Address of buffer y (on heap) : 0x804b008
$ a.out
Address of buffer x (on stack): 0xbffff370
Address of buffer y (on heap) : 0x804b008

$ sudo sysctl -w kernel.randomize_va_space=1
kernel.randomize_va_space = 1
$ a.out
```

```

Address of buffer x (on stack): 0xbf9deb10
Address of buffer y (on heap) : 0x804b008
$ a.out
Address of buffer x (on stack): 0xbf8c49d0
Address of buffer y (on heap) : 0x804b008

$ sudo sysctl -w kernel.randomize_va_space=2
kernel.randomize_va_space = 2
$ a.out
Address of buffer x (on stack): 0xbf9c76f0
Address of buffer y (on heap) : 0x87e6008
$ a.out
Address of buffer x (on stack): 0xbfe69700
Address of buffer y (on heap) : 0xa020008

```

4.8.2 Effectiveness of Address Randomization

The effectiveness on address randomization depends on several factors. A complete implementation of ASLR wherein all areas of process are located at random places may result in compatibility issues. A second limitation sometimes is the reduced range of the addresses available for randomization [Marco-Gisbert and Ripoll, 2014].

One way to measure the available randomness in address space is entropy. If a region of memory space is said to have n bits of entropy, it implies that on that system, the region's base address can take 2^n locations with an equal probability. Entropy depends on the type of ASLR implemented in the kernel. For example, in the 32-bit Linux OS, when static ASLR is used (i.e., memory regions except program image are randomized), the available entropy is 19 bits for stack and 13 bits for heap [Herlands et al., 2014].

In implementations where the available entropy for randomization is not enough, attackers can resolve to brute-force attacks. Proper implementations of ASLR (like those available in `grsecurity` [Wikipedia, 2017b]) provide methods to make brute force attacks infeasible. One approach is to prevent an executable from executing for a configurable amount of time if it has crashed a certain number of times [Wikipedia, 2017a].

Defeating stack randomization on 32-bit machine. As mentioned above, on 32-bit Linux machines, stacks only have 19 bits of entropy, which means the stack base address can have $2^{19} = 524,288$ possibilities. This number is not that high and can be exhausted easily with the brute-force approach. To demonstrate this, we write the following script to launch a buffer overflow attack repeatedly, hoping that our guess on the memory address will be correct by chance. Before running the script, we need to turn on the memory randomization by setting `kernel.randomize_va_space` to 2.

```

#!/bin/bash
... code is omitted for this sample chapter ...

```

In the above attack, we have prepared the malicious input in `badfile`, but due to the memory randomization, the address we put in the input may not be correct. As we can see from the following execution trace, when the address is incorrect, the program will crash (core dumped). However, in our experiment, after running the script for a little bit over 19

minutes (12524 tries), the address we put in `badfile` happened to be correct, and our shellcode gets triggered.

```

.....
19 minutes and 14 seconds elapsed.
The program has been running 12522 times so far.
...: line 12: 31695 Segmentation fault (core dumped) ./stack
19 minutes and 14 seconds elapsed.
The program has been running 12523 times so far.
...: line 12: 31697 Segmentation fault (core dumped) ./stack
19 minutes and 14 seconds elapsed.
The program has been running 12524 times so far.
#     ← Got the root shell!

```

We did the above experiment on a 32-bit Linux machine (our pre-built VM is a 32-bit machine). For 64-bit machines, the brute-force attack will be much more difficult.

Address randomization on Android. A popular attack on Android called stagefright was discovered in 2015 [Wikipedia, 2017e]. The bug was in Android’s stagefright media library, and it is a buffer overflow problem. Android has implemented ASLR, but it still had a limitation. As discussed by Google’s researchers, exploiting the attack depended on the available entropy in the `mmap` process memory region. On Android Nexus 5 running version 5.x (with 32-bit), the entropy was only 8-bit or 256 possibilities, making brute-force attacks quite easy [Brand, 2015].

4.9 StackGuard

Stack-based buffer overflow attacks need to modify the return address; if we can detect whether the return address is modified before returning from a function, we can foil the attack. There are many ways to achieve that. One way is to store a copy of the return address at some other place (not on the stack, so it cannot be overwritten via a buffer overflow), and use it to check whether the return address is modified. A representative implementation of this approach is Stackshield [Angelfire.com, 2000]. Another approach is to place a guard between the return address and the buffer, and use this guard to detect whether the return address is modified or not. A representative implementation of this approach is StackGuard [Cowa et al., 1998]. StackGuard has been incorporated into compilers, including `gcc`. We will dive into the details of this countermeasure.

4.9.1 The Observation and the Idea

The key observation of StackGuard is that for a buffer overflow attack to modify the return address, all the stack memory between the buffer and the return address will be overwritten. This is because the memory-copy functions, such as `strcpy()` and `memcpy()`, copy data into contiguous memory locations, so it is impossible to selectively affect some of the locations, while leaving the other intact. If we do not want to affect the value in a particular location during the memory copy, such as the shaded position marked as `Guard` in Figure 4.10, the only way to achieve that is to overwrite the location with the same value that is stored there.

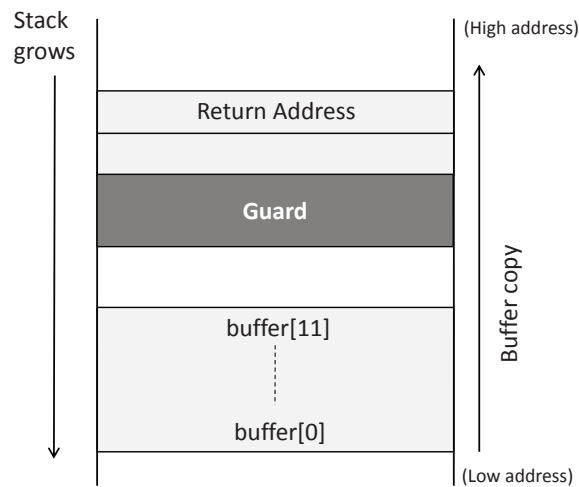

Figure 4.10: The idea of StackGuard

Based on this observation, we can place some non-predictable value (called guard) between the buffer and the return address. Before returning from the function, we check whether the value is modified or not. If it is modified, chances are that the return address may have also been modified. Therefore, the problem of detecting whether the return address is overwritten is reduced to detecting whether the guard is overwritten. These two problems seem to be the same, but they are not. By looking at the value of the return address, we do not know whether its value is modified or not, but since the value of the guard is placed by us, it is easy to know whether the guard's value is modified or not.

4.9.2 Manually Adding Code to Function

Let us look at the following function, and think about whether we can manually add some code and variables to the function, so in case the buffer is overflowed and the return address is overwritten, we can preempt the returning from the function, thus preventing the malicious code from being triggered. Ideally, the code we add to the function should be independent from the existing code of the function; this way, we can use the same code to protect all functions, regardless of what their functionalities are.

```
void foo (char *str)
{
    char buffer[12];
    strcpy (buffer, str);

    return;
}
```

First, let us place a guard between the buffer and the return address. We can easily achieve that by defining a local variable at the beginning of the function. It should be noted that in

reality, how local variables are placed on the stack and in what order is decided by the compiler, so there is no guarantee that the variable defined first in the source code will be allocated closer to the return address. We will temporarily ignore this fact, and assume that the variable (called `guard`) is allocated between the return address and the rest of the function's local variables.

We will initialize the variable `guard` with a secret. This secret is a random number generated in the main function, so every time the program runs, the random number is different. As long as the secret is not predictable, if the overflowing of the buffer has led to the modification of the return address, it must have also overwritten the value in `guard`. The only way not to modify `guard` while still being able to modify the return address is to overwrite `guard` with its original value. Therefore, attackers need to guess what the secret number is, which is difficult to achieve if the number is random and large enough.

One problem we need to solve is to find a place to store the secret. The secret cannot be stored on the stack; otherwise, its value can also be overwritten. Heap, data segment, and BSS segment can be used to store this secret. It should be noted that the secret should never be hard-coded in the code; or it will not be a secret at all. Even if one can obfuscate the code, it is just a matter of time before attackers can find the secret value from the code. In the following code, we define a global variable called `secret`, and we initialize it with a randomly-generated number in the main function (not shown). As we have learned from the beginning of the section, uninitialized global variables are allocated in the BSS segment.

```
// This global variable will be initialized with a random
// number in the main function.
int secret;

void foo (char *str)
{
    int guard;
    guard = secret;

    char buffer[12];
    strcpy (buffer, str);

    if (guard == secret)
        return;
    else
        exit(1);
}
```

From the above code, we can also see that before returning from the function, we always check whether the value in the local variable `guard` is still the same as the value in the global variable `secret`. If they are still the same, the return address is safe; otherwise, there is a high possibility that the return address may have been overwritten, so the program should be terminated.

4.9.3 StackGuard Implementation in gcc

The manually added code described above illustrates how StackGuard works. Since the added code does not depend on the program logic of the function, we can ask compilers to do that for us automatically. Namely, we can ask compilers to add the same code to each function: at the beginning of each function, and before each return instruction inside the function.

The `gcc` compiler has implemented the StackGuard countermeasure. If you recall, at the beginning of this chapter, when we launched the buffer overflow attack, we had to turn off the StackGuard option when compiling the vulnerable program. Let us see what code is added to each function by `gcc`. We use our pre-built 32-bit x86-based Ubuntu VM in our investigation. The version of `gcc` is 4.6.3. The following listing shows the program from before, but containing no StackGuard protection implemented by the developer.

```
#include <string.h>
#include <stdio.h>
#include <stdlib.h>

void foo(char *str)
{
    char buffer[12];

    /* Buffer Overflow Vulnerability */
    strcpy(buffer, str);
}

int main(int argc, char *argv[]){

    foo(argv[1]);

    printf("Returned Properly \n\n");
    return 0;
}
```

We run the above code with arguments of different length. In the first execution, we use a short argument, and the program returns properly. In the second execution, we use an argument that is longer than the size of the buffer. Stackguard can detect the buffer overflow, and terminates the program after printing out a "stack smashing detected" message.

```
seed@ubuntu:~$ gcc -o prog prog.c
seed@ubuntu:~$ ./prog hello
Returned Properly

seed@ubuntu:~$ ./prog hello000000000000
*** stack smashing detected ***: ./prog terminated
```

To understand how StackGuard is implemented in `gcc`, we examine the assembly code of the program. We can ask `gcc` to generate the assembly code by using the "-S" flag (`gcc -S prog.c`). The assembly code is shown in the listing below. The section where the guard is set and checked is highlighted and will be explained next.

```
foo:
.LFB0:
    .cfi_startproc
    pushl   %ebp
    .cfi_def_cfa_offset 8
    .cfi_offset 5, -8
    movl   %esp, %ebp
    .cfi_def_cfa_register 5
```

```

subl    $56, %esp
movl    8(%ebp), %eax
movl    %eax, -28(%ebp)
// Canary Set Start
movl %gs:20, %eax
movl %eax, -12(%ebp)
xorl %eax, %eax
// Canary Set End
movl    -28(%ebp), %eax
movl    %eax, 4(%esp)
leal    -24(%ebp), %eax
movl    %eax, (%esp)
call    strcpy
// Canary Check Start
movl -12(%ebp), %eax
xorl %gs:20, %eax
je .L2
call __stack_chk_fail
// Canary Check End
.L2:
leave
.cfi_restore 5
.cfi_def_cfa 4, 4
ret
.cfi_endproc

```

We first examine the code that sets the guard value on stack. The relevant part of the code is shown in the listing below. In StackGuard, the guard is called *canary*.

```

movl    %gs:20, %eax
movl    %eax, -12(%ebp)
xorl    %eax, %eax

```

The code above first takes a value from `%gs:20` (offset 20 from the GS segment register, which points to a memory region isolated from the stack). The value is copied to `%eax`, and then further copied to `%ebp-12`. From the assembly code, we can see that the random secret used by StackGuard is stored at `%gs:20`, while the canary is stored at location `%ebp-12` on the stack. The code basically copies the secret value to canary. Let us see how the canary is checked before function return.

```

movl    -12(%ebp), %eax
xorl    %gs:20, %eax
je .L2
call __stack_chk_fail
.L2:
leave
ret

```

In the code above, the program reads the canary on the stack from the memory at `%ebp-12`, and saves the value to `%eax`. It then compares this value with the value at `%gs:20`, where canary gets its initial value. The next instruction, `je`, checks if the result of the previous operation (XOR) is 0. If yes, the canary on the stack remains intact, indicating that no overflow

has happened. The code will proceed to return from the function. If `je` detected that the XOR result is not zero, i.e., the canary on stack was not equal to the value at `%gs:20`, an overflow has occurred. The program call `__stack_chk_fail`, which prints an error message and terminates the program.

Ensuring Canary Properties As discussed before, for the StackGuard solution, the secret value that the canary is checked against needs to satisfy two requirements:

- It needs to be random.
- It cannot be stored on the stack.

The first property is ensured by initializing the canary value using `/dev/urandom`. More details about it can be found at the link [xorl, 2010]. The second property is ensured by keeping a copy of the canary value in `%gs:20`. The memory segment pointed by the `GS` register in `Linux` is a special area, which is different from the stack, heap, BSS segment, data segment, and the text segment. Most importantly, this `GS` segment is physically isolated from the stack, so a buffer overflow on the stack or heap will not be able to change anything in the `GS` segment. On 32-bit x86 architectures, `gcc` keeps the canary value at offset 20 from `%gs` and on 64-bit x86 architectures, `gcc` stores the canary value at offset 40 from `%gs`.

4.10 Summary

Buffer overflow vulnerabilities are caused when a program puts data into a buffer but forgets to check the buffer boundary. It does not seem that such a mistake can cause a big problem, other than crashing the program. As we can see from this chapter, when a buffer is located on the stack, a buffer overflow problem can cause the return address on the stack to be overwritten, resulting in the program to jump to the location specified by the new return address. By putting malicious code in the new location, attackers can get the victim program to execute the malicious code. If the victim program is privileged, such as a `Set-UID` program, a remote server, a device driver, or a root daemon, the malicious code can be executed using the victim program's privilege, which can lead to security breaches.

Buffer overflow vulnerability was the number one vulnerability in software for quite a long time, because it is quite easy to make such mistakes. Developers should use safe practices when saving data to a buffer, such as checking the boundary or specifying how much data can be copied to a buffer. Many countermeasures have been developed, some of which are already incorporated in operating systems, compilers, software development tools, and libraries. Not all countermeasures are fool-proof; some can be easily defeated, such as the randomization countermeasure for 32-bit machines and the non-executable stack countermeasure. In Chapter 5, we show how to use the return-to-libc attack to defeat the non-executable stack countermeasure.